



Spec. No.	PS-ND-08090413
Rev.	A

PRODUCT SPECIFICATION

Model No : CSM-58211G/58221G

Descriptions:

- 2.3 Inch 5X8 Dot-Matrix Display
- Dot Pitch 7.62mm
- CSM-58211: Column Anode, Row Cathode
- CSM-58221: Column Cathode, Row Anode
- Emitting Color: Yellow Green



CUSTOMER APPROVED SIGNATURES	APPROVED BY	CHECKED BY	PREPARED BY

CHINA SEMICONDUCTOR CORPORATION

Address:2FL. NO.909,Chung-Cheng Road,
Chung-Ho City Taipei Hsien,Taiwan.

Tel:886-2-2223-9696
Fax:886-2-2223-9377

OPTO PLUS TECHNOLOGIES CO.,LTD

Address:696 Shun jiang Rd.,Ji Shan St.Shaoxing,
ZheJiang,China

Tel:86-0575-8623888
Fax:86-0575-8623112



Model No : CSM-58211/58221G

■ Features -

1. 2.3 inch (58.34mm) Matrix height.
2. Case mold type.
3. RoHs compliant.
4. Low power consumption.
5. Easy mounting on P.C. board or socket.

■ Device Selection Guide -

Part No.	Chip		Column	Row
	Material	Emitted Color		
CSM-58211G	GaP	Yellow Green	Anode	Cathode
CSM-58221G	GaP	Yellow Green	Cathode	Anode

■ Package Dimensions -

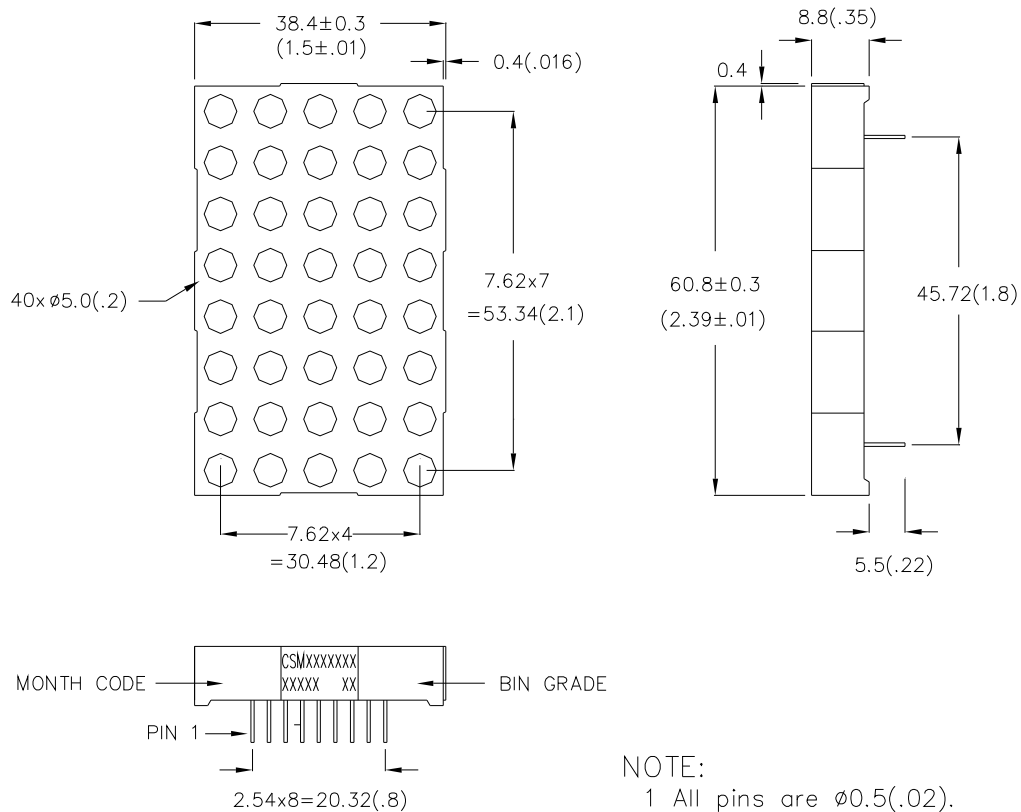

NOTE:

- 1 All pins are $\phi 0.5$ (.02).
- 2 Dimension in millimeters (inch), tolerance is ± 0.25 (.01) unless otherwise noted.



Model No : CSM-58211/58221G

Internal Circuit Diagrams -

CSM-58221

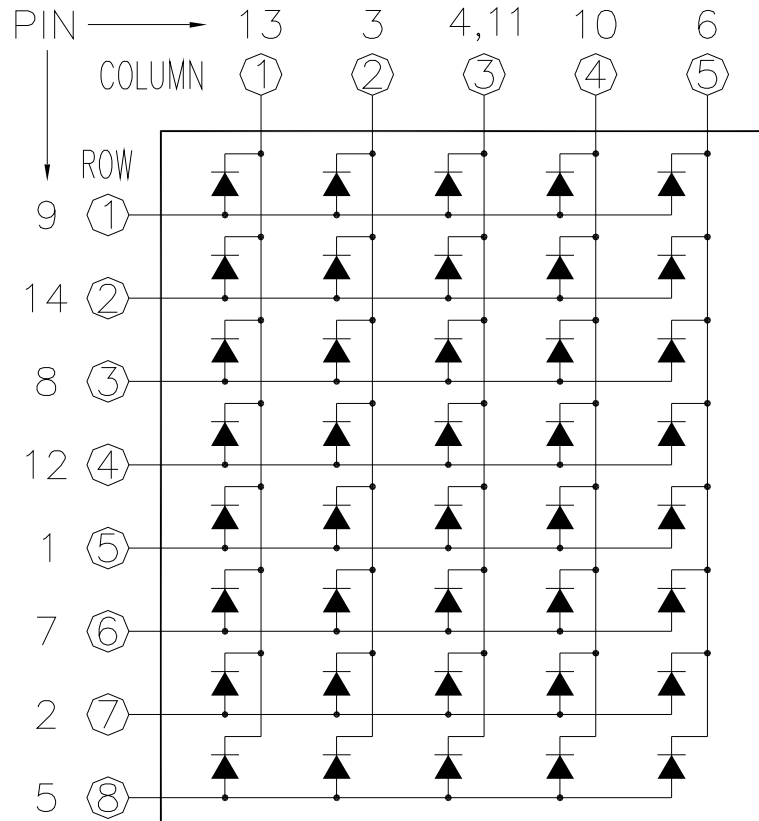

CSM-58211				CSM-58221			
PIN NO.	FUNCTION	PIN NO.	FUNCTION	PIN NO.	FUNCTION	PIN NO.	FUNCTION
1	Cathode Row 5	8	Cathode Row 3	1	Anode Row 5	8	Anode Row 3
2	Cathode Row 7	9	Cathode Row 1	2	Anode Row 7	9	Anode Row 1
3	Anode Column 2	10	Anode Column 4	3	Cathode Column 2	10	Cathode Column 4
4	Anode Column 3	11	Anode Column 3	4	Cathode Column 3	11	Cathode Column 3
5	Cathode Row 8	12	Cathode Row 4	5	Anode Row 8	12	Anode Row 4
6	Anode Column 5	13	Anode Column 1	6	Cathode Column 5	13	Cathode Column 1
7	Cathode Row 6	14	Cathode Row 2	7	Anode Row 6	14	Anode Row 2



Model No : CSM-58211/58221G

■ Absolute Maximum Rating -

(Ta=25°C)

Parameter	Symbol	Rating	Unit
Power Dissipation Per Dice	Pd	70	mW
Continuous Forward Current Per Dice	IAF	25	mA
Peak Current Per Dice(duty cycle 1/10, 1kHz)	IPF	90	mA
Derating Linear From 25°C Per Dice	-	0.33	mA/°C
Reverse Voltage Per Dice	VR	5	V
Operating Temp.	Topr	-35 ~ +85	°C
Storage Temp.	Tstg	-35 ~ +85	°C
Solder temperature 1/16 inch below seating plane for 3 seconds at 260°C			

■ Electro-optical Characteristics -

(Ta=25°C)

Parameter	Symbol	Min.	Typ.	Max.	Unit	Condition
Forward Voltage Per Segment	VF	-	2.1	2.8	V	IF=20mA
Luminous Intensity Per Segment	Iv	-	7	-	mcd	IF=10mA
Peak Emission Wavelength	λ_p	-	568	-	nm	IF=20mA
Dominant Wavelength	λ_d	-	572	-	nm	IF=20mA
Spectrum Radiation Bandwidth	$\Delta \lambda$	-	30	-	nm	IF=20mA
Reverse Current	IR	-	-	100	μA	VR=5V
Luminous Intensity Matching Ratio	IV-m	-	-	2:1	-	IF=10mA



Model No : CSM-58211/58221G

■ Typical Electrical / Optical Characteristics Curves -

(Ta = 25°C Unless Otherwise Noted)

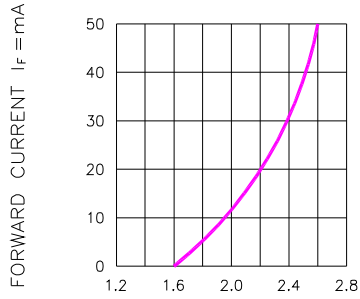

FORWARD VOLTAGE (V_F) -VOLTS

Fig.1 FORWARD CURRENT VS. FORWARD VOLTAGE

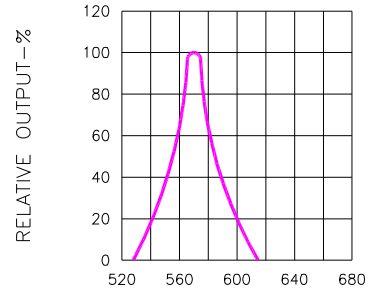

WAVELENGTH (λ) -nm

Fig.2 SPECTRAL RESPONSE

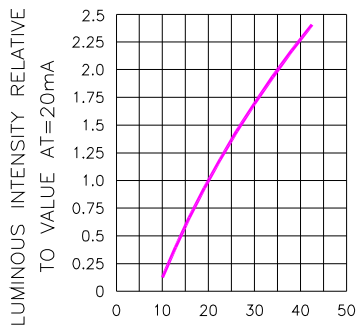

I_F -FORWARD CURRENT -mA

Fig.3 RELATIVE LUMINOUS INTENSITY VS. FORWARD CURRENT

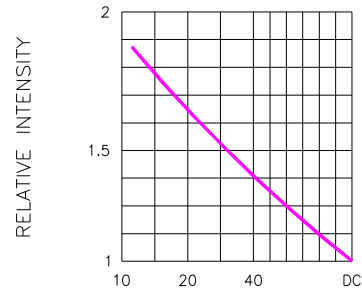

DUTY CYCLE % PER SEGMENT
(AVERAGE I_F = 10mA)

Fig.5 LUMINOUS INTENSITY VS. DUTY CYCLE

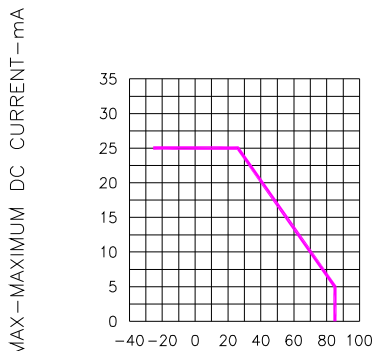

T_A AMBIENT TEMPERATURE °C

Fig.4 MAXIMUM ALLOWABLE DC CURRENT PER SEGMENT VS. A FUNCTION OF AMBIENT TEMPERATURE

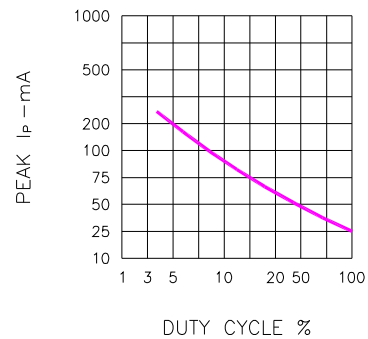

Fig.6 MAX PEAK CURRENT VS. DUTY CYCLE %
(REFRESH RATE f=1 KHz)